



AMERICAN LIGHTING
BRIGHT IDEAS • INNOVATIVE SOLUTIONS

EPIQ 4

LED Retrofit Recessed Downlight for 4" Housings
Installation instructions for E4 Series



EPIQ 4 Retrofit Downlight



Installation Instructions for E4 Series 120V AC Operation

WARNING: These products may represent a possible shock or fire hazard if improperly installed or attached in any way. Products should be installed in accordance with these instructions, current electrical codes, and/or the current National Electric Code (NEC).

WARNING: READ ALL INSTRUCTIONS BEFORE YOU START:

CAUTION - To reduce risk of fire, electric shock, or injury to persons: To avoid possible electric shock, be sure that power supply is turned off at fuse box or circuit breaker before attempting installation or servicing of the fixture. For safest operation, read and become familiar with complete installation instructions prior to use. Pay close attention to this manual and stay within its guidelines when using this product.

CAUTION - To reduce risk of fire, electric shock, or injury to persons: Use with 4" recessed cans (recessed housing) only. Do not attempt to alter for other sizes or purposes. The electrical rating of this product is 120V AC. The installer must determine whether power supply is appropriate at the luminaire before installation.

WARNING:

Risk of fire or electric shock. LED retrofit kit installation requires knowledge of recessed lighting luminaires and their electrical systems. If not qualified or uncertain, do not attempt installation: contact a qualified electrician.

Risk of fire or electric shock. Supply conductors (power wiring) connecting the fixture must be rated for a minimum of 90°C.

Risk of fire or electric shock. Do not make or alter any open holes in wiring enclosures, nor in any electrical components during kit installation.

Risk of fire or electric shock. Do not alter, relocate, or remove wiring, lamp holders, power supply, or any other electrical component.

Risk of fire or electric shock. Do not use these products in luminaires located where elevated ambient temperatures exist.

Risk of fire or electric shock. To prevent wiring damage or abrasion, do not expose wiring to edges of sheet metal or other sharp objects.

ADDITIONAL SAFETY MEASURES

1. To avoid electrical shock, do not turn on fixture with missing or damaged lens.
2. There are no serviceable parts inside LED module.
3. Use only a mild soap and water with soft cloth to clean the fixture. Harsh chemicals will damage the finish. Do not wipe the fixture with a rough cloth that may scratch the finish or the lens.

CONTENTS

Each E4 retrofit LED recessed downlight kit includes an attached lead wire with a 120V plastic connector, an Edison (E26) socket adaptor with mating 120V plastic connector, and a pair of attached torsion clips. See Figure 1.

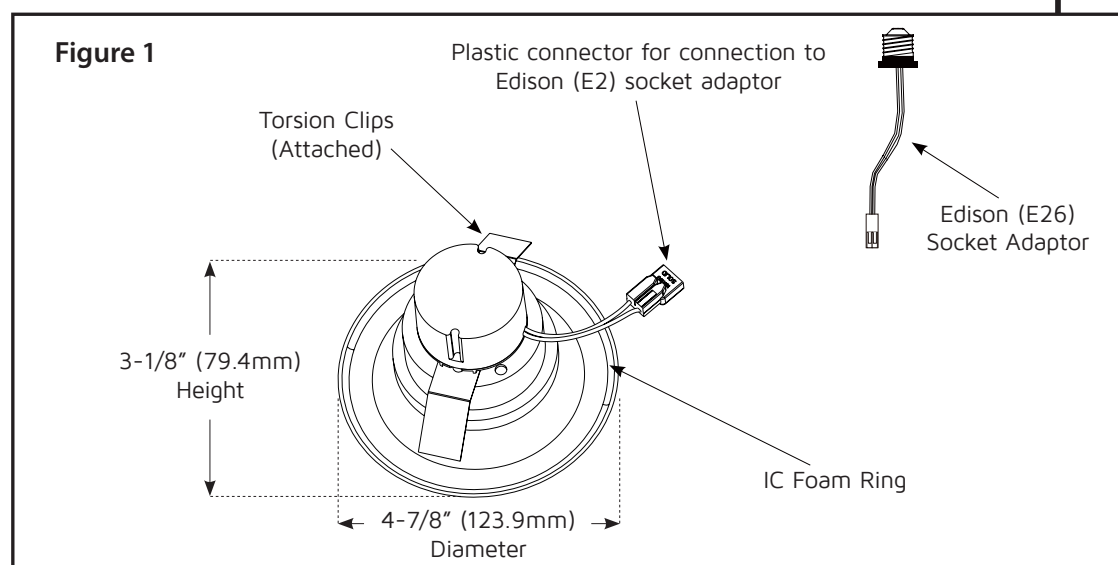

Continued on next page...



EPIQ 4 Retrofit Downlight



Installation Instructions for E4 Series
120V AC Operation

COMPATIBLE HOUSINGS

This retrofit recessed light kit is compatible with the AL4-ICAT (sold separately) recessed housing and will work with most standard 4" housings (recessed cans). It has a built-in trim and does not require any additional trim, though optional click-on trims are available (CLIQ series sold separately).

This retrofit recessed light is intended for installing in the field in recessed type IC luminaires with dimensions as follows:

Minimum Height Requirement	Location
3-7/8" (98.5mm)	Indoor/Outdoor Dry, Damp, or Wet location

INSTALLATION OF 4" RETROFIT RECESSED LIGHT INTO RECESSED CANS

1. Confirm the 4" recessed housing is compatible with the retrofit LED module.
2. Remove socket mounting bracket and plate from inside existing recessed housing (if installed).
3. Remove socket from plate and discard plates.
4. Screw Edison base (E26) socket adaptor into back of recessed housing. See figure 2.
5. Plug the retrofit fixture's plastic connector into the plastic connector of the Edison base (E26) socket adaptor. See figure 3.
6. Carefully route wires into housing and push retrofit fixture up flush to ceiling surface.

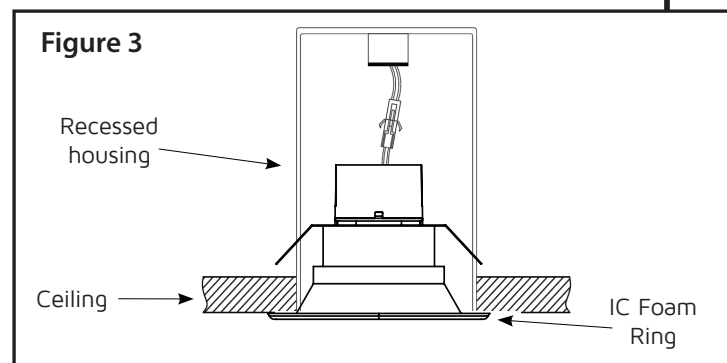
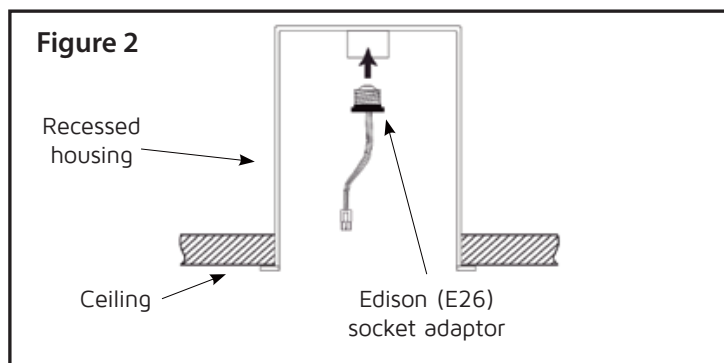

Continued on next page...

EPIQ 4 Retrofit Downlight



Installation Instructions for E4 Series 120V AC Operation

REMOVING 4" RETROFIT RECESSED LIGHT

1. With fingertips, pull down firmly on trim ring until retrofit fixture lowers from ceiling and stops.
2. Squeeze torsion springs together to remove LED module.
3. Disconnect LED module from recessed housing by unplugging plastic connectors and removing Edison (E26) socket adaptor.

LIGHT DISTRIBUTION

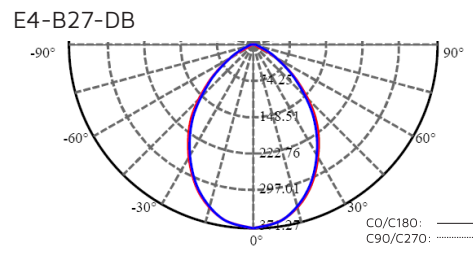
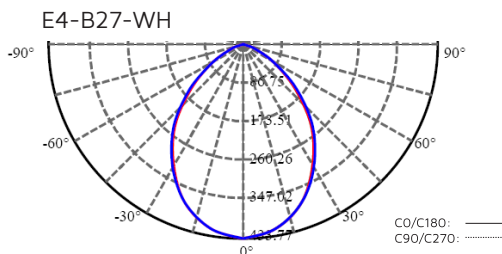
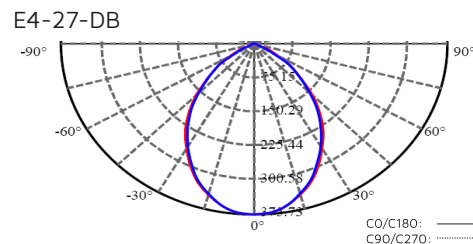
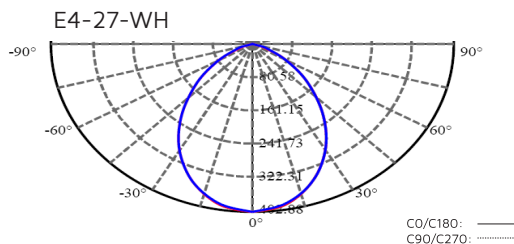

5-YEAR LIMITED PRODUCT WARRANTY

This product is warranted to be free from defects in material and workmanship for a period of five (5) years from the date of purchase. Products that prove to be defective during this period will be either repaired (i.e. replacement of defective electronics, defective parts of the fixture housing, lens, wiring, switching or lamp sockets; excluding the lamp) or replaced, at the discretion of American Lighting, Inc. Claims for defective products must be submitted to the retail location from which the product was purchased within the warranty period. Upon submission of proper return claim documentation and product to American Lighting, Inc. by the retailer, American Lighting, Inc. reserves the right to inspect the product for misuse or abuse. Claims for indirect or consequential damages or for product that, in American Lighting, Inc's opinion has been misused, will be denied. This is a warranty of product reliability only and not a warranty of merchantability or fitness for a particular purpose. American Lighting, Inc shall have no liability whatsoever in any event for payment of incidental or consequential damages, including, without limitations, installation costs and damages for personal injury and property. These products may represent a possible shock or fire hazard if improperly installed or altered in any way. This warranty applied only to product that has been properly installed in accordance with instruction sheet and current local codes and/or the National Electrical Code. Warranty does not apply to any product that has been improperly installed or in situation where components have been altered in any way. This warranty: (1) excludes expendable parts including but not limited to light bulbs, batteries; (2) carries a 2-year finish warranty protecting finish against tarnishing, flaking, and discolorations; (3) shall be void if this lighting fixture is not installed in the U.S.A.; and (4) does not cover any losses, labor, injuries to persons/property or costs. This warranty does give you specific legal rights and you may have other rights, which vary from state to state. Be careful, it is recommended that installation be done by a qualified professional; the purchaser has sole responsibility for proper installation in compliance with all state and local code requirements. Seller's employees are not qualified to advise you on the use of this Merchandise. Any oral representation(s) made will not be binding on seller or its employees. The rights under this limited warranty are to the original purchaser of the Merchandise and may not be transferred to any subsequent owner. This limited warranty is in lieu of all warranties, expressed or implied including warranties or merchantability and fitness for a particular purpose. Seller shall not be liable for any special, incidental, or consequential damages. The sold exclusive remedy against the seller will be for the replacement of any defects as provided herein, as long as the seller is willing or able to replace this product or is willing to refund the purchase price as provided above.

For questions/comments, technical assistance, or repair parts - Please call toll free at 1-800-285-8051 (M-F 8am-5pm), CST)