



PROJECT: \_\_\_\_\_ TYPE: \_\_\_\_\_

LOCATION: \_\_\_\_\_ CAT: \_\_\_\_\_



### Description

Use Commercial Grade Light String for decorative, event oriented, or festive lighting applications.

### Features

- 14AWG SJTW 2-wire light string available in 48ft or 100ft 'Cord and Plug' sets as well as 330ft bulk reels
- Formulated PVC sockets form a tight seal around bulbs to preclude the entrance of water and moisture
- Suspended socket has T-mold with mounting hole at top while non-suspended socket has two mounting ears built into the base
- Use with E26 base Long Life Incandescent Lamps or Pro Decorative Lamps (sold separately)

### Mounting

For spans up to 20 feet, use eye bolts and plastic ties to anchor ends. For spans longer than 20 feet, use catenary cable (sold separately) with plastic ties at each socket.

### Applications

Patios, overhangs, outdoor living areas, tents for weddings or festivals, event lighting



## Technical Information

Series	LS-M-24-48-GR	LS-M-24-100-BK	LS-M-24-BK	LS-M-24-GR	LS-MS-24-48-BK	LS-MS-24-48-GR	LS-MS-24-100-BK	LS-MS-24-100-WH	LS-MS-24-BK	LS-MS-24-WH	LS-MS-24-GR	
Length	48ft	100ft	330ft	330ft	48ft	48ft	100ft	100ft	330ft	330ft	330ft	
Socket Type	Non-suspended E26 Base				Suspended E26 Base							
Socket Spacing	24"											
Total Sockets	24	50	165	165	24	24	50	50	165	165	165	
Wire Color	Green	Black	Black	Green	Black	Green	Black	White	Black	White	Green	
Wire Type	14AWG SJTW 2-wire with 120V plug and terminated end	14AWG SJTW 2-wire with 120V plug and terminated end	14AWG SJTW 2-wire; No plug, No terminated end		14AWG SJTW 2-wire with 120V plug and terminated end		14AWG SJTW 2-wire with 120V plug and terminated end		14AWG SJTW 2-wire; No plug, No terminated end			
Voltage	120V AC, 60Hz											
Max Watts Per Socket	25 watts max per socket											
Max Watts Per String	600 watts	1250 watts	1800 watts	1800 watts	600 watts	600 watts	1250 watts	1250 watts	1800 watts	1800 watts	1800 watts	
Cuttability	All cut ends must be sealed with LS-M//MS-END and/or electrical tape (sold separately)**											
Rating	Indoor/Outdoor; Suitable for year-round use*; IP64**											
Rated Life	Varies by lamp used											

\* All LS products are non-rated; Not intended for installation in ceilings, soffits, cabinets or other enclosed spaces.

\*\*For non-rated LS product, any cut ends must be sealed with LS-M//MS-END and/or electrical tape (ensure proper seal to preclude entrance of water). Keep lamp at least 4.9m/16ft from pools and spas.

### LS-M Socket Dimensions

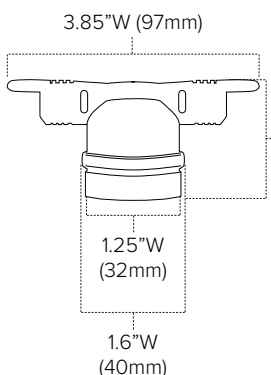

### LS-MS Socket Dimensions

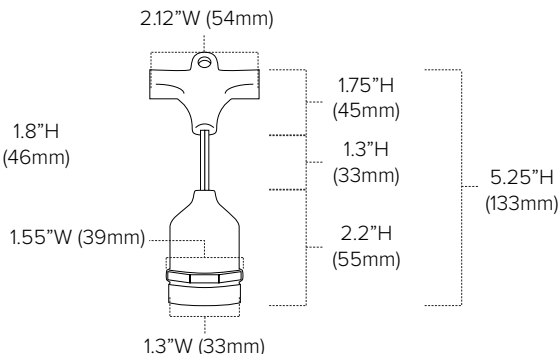

### LS 'Cord and Plug' set Lead Wire: 16"L (405mm)

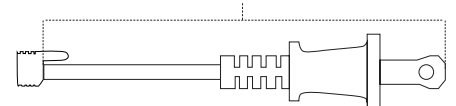

### LS 'Cord and Plug' set Tail Wire: 9"L (225mm)

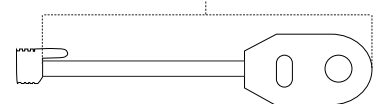

### LS '330ft Reel' Lead Wire: 72"L (182cm)

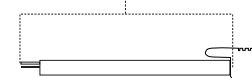

## Ordering Information

### 120V LS E26 Series 48ft 'Cord and Plug' sets

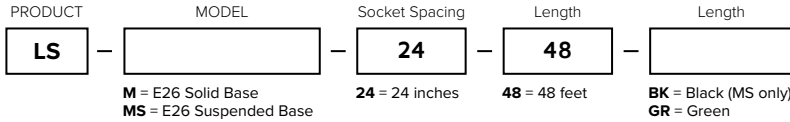

### 120V LS E26 Series 48ft 'Cord and Plug' Sets Include:

(1) 48ft length of LS series commercial grade light string with 120V plug and terminated end

### 120V LS E26 Series 100ft 'Cord and Plug' sets

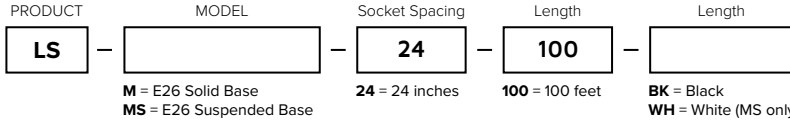

### 120V LS E26 Series 100ft 'Cord and Plug' Sets Include:

(1) 100ft length of LS series commercial grade light string with 120V plug and terminated end

### 120V LS E26 Series 330ft Bulk Reels

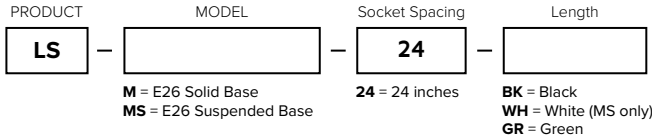





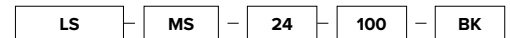

### 120V LS E26 Series 330ft Bulk Reels Include:

(1) 330ft length of LS series commercial grade light string without plug and without terminated end

Example Part # **LS-MS-24-100-BK**



## Accessories

Image	Item	Description
	LS-M/MS-END	Black plastic end cap for 14AWG SJTW Commercial Grade Light String
	Compatible Lamps	Pro Decorative Series: PS14-E26, PA15-E26, PG50-E26, PG45-E26, PG40-E26, and PC7 Standard LED Series: S14-LED Long Life Incandescent B-Series: B7.5S11 and B11S14
	LS-CABLE-60	60ft Catenary Cable Kit Includes: (1) 60ft length of 1/8" diameter catenary/guide cable for light string installation, (2) Heavy duty cable locks, and (1) Cable release key
	LS-CABLE-110	110ft Catenary Cable Kit Includes: (1) 110ft length of 1/8" diameter catenary/guide cable for light string installation, (2) Heavy duty cable locks, and (1) Cable release key
	LS-CABLE-500	500ft Catenary Cable Bulk Reel Includes: (1) 500ft length of 1/8" diameter catenary/guide cable for light string installation
	LS-LOCK-4	(4) Heavy duty cable locks for 1/8" catenary cable; Support loads up to 330lbs; Includes cable release key
	LS-TT	Tensioning Tool; use to eliminate sag from catenary cable. Never tighten cable before load is attached; Never over-tighten cable

## Additional Information

### SUSPENDING LIGHT STRINGS:

Light sockets must be suspended so that bulbs are facing down only. **DO NOT MOUNT THE LIGHT STRINGS WITH SOCKETS FACING UPWARD!**

1. Light string must be securely attached to a support structure at each end of each span. The maximum unsupported span distance for 48' Cord & Plug Light String is 20 feet (10 sockets).
2. Secure light string to supporting hardware (eyebolts, brackets, etc., not provided) using cable ties (not included). See Figure 1.
3. Ensure any cut ends are properly sealed to preclude the entrance of water.
4. For spans exceeding 20 feet, use properly rated cable support system and cable ties (neither are provided with the light string) and follow local codes for suspended cables and loads. See [www.americanlighting.com](http://www.americanlighting.com) for steel cable support systems, if needed.

