

120V | EPIQ 4 Retrofit Downlight

PROJECT: TYPE:

LOCATION: CAT:



Dark Bronze



White

Description

Versatile and affordable LED retrofit downlight in 2 finishes with either smooth or baffle insets for 4" recessed housings

Features

- Metal core PCB with aluminum heat sink
- Stamped aluminum trims with durable baked enamel finish
- Frosted polycarbonate lens diffuses light
- Compatible with CLIQ4 square trims in 3 finishes and either smooth or baffle inset
- Square click-on trims are injection molded heavy-duty plastic with polyurethane finish
- cETLus Listed for Type IC and wet locations

Mounting

Retrofit: Steel torsion clips secure downlight into most standard 4" cans (requires 3-7/8" clearance) with E26 sockets; Compatible with AL4-ICAT recessed housing (sold separately)

Applications

General Lighting LED Retrofit

Warranty

5 years

Technical Information



Voltage	120V AC, 60Hz			
CCT	2700K		4000K	
Series	E4-B27		E4-27	
Finish	DB	WH	DB	WH
Lumens	630	8117	630	765
Wattage	9.5W			
CRI	90+			
Inset	Baffle		Smooth	
Beam Angle	86°			
Dimming	5-100% with most standard incandescent (TRIAC) and low-voltage electronic dimmers			
Rating	Energy Star; cETLus Listed; Type IC; Wet location			
Rated Life	35,000 Hours			

E4 Module Profile View

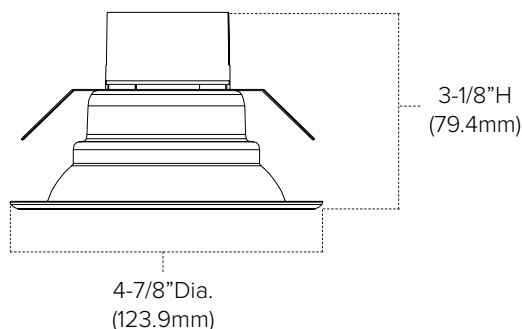

E4 Module Plan View

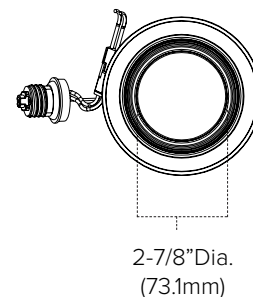

Ordering Information

120V AC, 60Hz 4" Retrofit

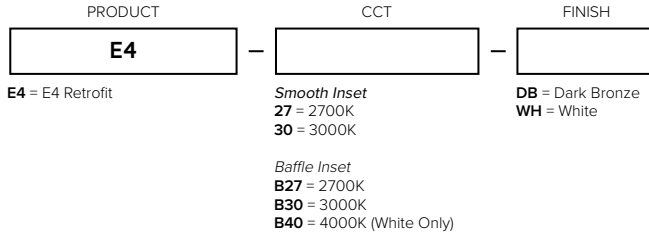

E4 Retrofit Downlights Include:

(1) 4" Retrofit downlight with standard E26 Edison socket connection and steel torsion mounting brackets to fit most standard 4" housings

Example Part # **E4-30-DB**







Compatible Dimmers

Brand	Model #	Type	Dimming Range	Notes
Lutron® Diva	DVCL-153PH	Universal (CFL/LED/Incandescent)	5-100%	
Lutron® Skylark	S-600PH	Incandescent	5-100%	
Leviton® Sureslide	6613	Incandescent	5-100%	

Minimum loads may apply. Dimmer performance may vary in field application due to unknown external factors. Dimmers not included on the chart above are not necessarily incompatible; they have yet to be fully evaluated. Please reference dimmer manufacturer's instructions for more detailed information regarding performance and compatibility.

Accessories

Image	Part Number	Description
	Q4-DB	Square CLIQ Trim for E4; Smooth inset; Dark Bronze finish
	Q4-NK	Square CLIQ Trim for E4; Smooth inset; Nickel finish
	Q4-WH	Square CLIQ Trim for E4; Smooth inset; White finish
	Q4-B-DB	Square CLIQ Trim for E4; Baffle inset; Dark Bronze finish
	Q4-B-NK	Square CLIQ Trim for E4; Baffle inset; Nickel finish
	Q4-B-WH	Square CLIQ Trim for E4; Baffle inset; White finish
	AL4-ICAT	4" Universal Airtight Type IC rated recessed housing; 120V AC, 60Hz; 50W Max (non-LED); cETLus Listed; New construction only
	AL-GU24	GU24 conversion adaptor for Title 24 compliance (replaces E26 adaptor); Includes 8" lead wire

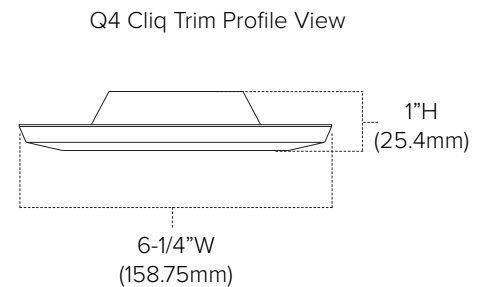

CLIQ Trims are only compatible with EPIQ series downlights.

Additional Information

Minimum Height Requirements

Minimum Height Requirement	Location
3-7/8" (111.2mm)	Indoor/Outdoor Dry, damp, or wet location

Using CLIQ trims with EPIQ downlights

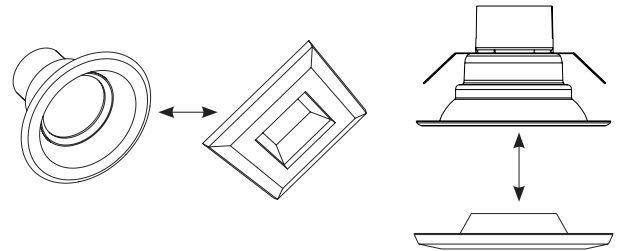

Photometrics

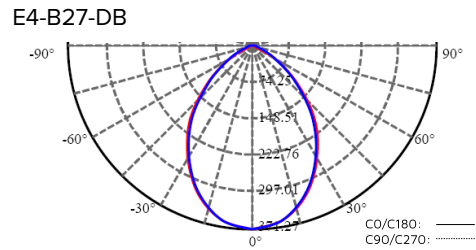
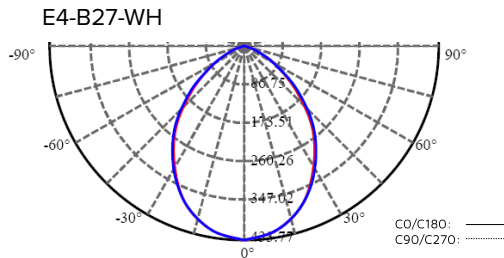
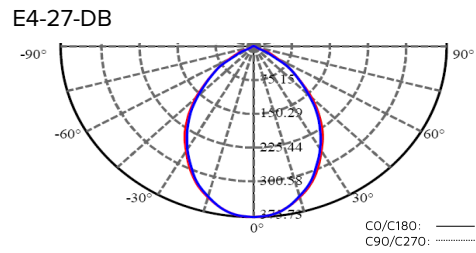
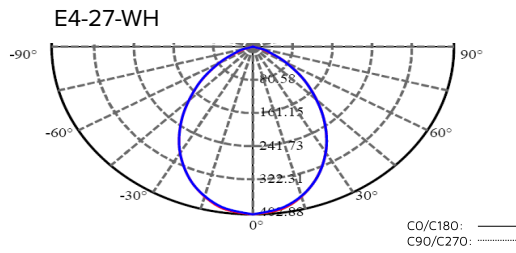

NOTES
