

PROJECT: TYPE:

LOCATION: CAT:



Description

Low-profile LED Linear lighting with superb light output for indoor and outdoor use

Features

- Each kit includes: (1) 5ft removable power cord with 8A inverter (H2-CONKIT-8A), (1) Removable end cap, and Mounting Clips (1 per foot of length)
- Parallel wiring to each LED ensures that if one LED goes out, the rest of the cutting increment stays lit
- Flexible rubber housing with clear PVC lens are protected with UV inhibitor
- Various mounting, linking, and power accessories available (sold separately)
- Minimum bend radius of 3.9"

Mounting

Mounting clips or mounting track

Applications

Accent Lighting, Coves, Ledges, Shelves

Warranty

1 year Standard Linear

Technical Information



Hybrid 2 Kits												
Voltage	120V AC, 60Hz											
CCT	Warm White (2700K)						Bright White (5000K)					
Length	3ft	6ft	12ft	18ft	30ft	45ft	3ft	6ft	12ft	18ft	30ft	45ft
Wattage	9W	18W	36W	54W	90W	135W	9W	18W	36W	54W	90W	135W
Lumens	145Lm/Ft						180Lm/ft					
CRI	82+											
Max Run	150 feet											
Beam Angle	120°											
Dimming	10-100% with most incandescent, low-voltage magnetic, and low-voltage electronic dimmers*											
Operating Temp	-30°C (-22°F) to 45°C (113°F)**											
Ambient Temp	-20°C (-4°F) to 42°C (107.6°F)**											
Storage Temp	-10°C (14°F) to 30°C (86°F)**											
LED Spacing	Every 5/8"; 20 per foot											
Rating	cETLus Listed (void if cut); Indoor/Outdoor; IP65											
Rated Life	30,000 Hours											

*Minimum loads may apply. Per the NEC, switched wall outlets cannot be used with wall dimmers.

**Do not install in inclement weather or extreme temperature conditions (i.e. -25°C (-13°F) and below)

Dimensions

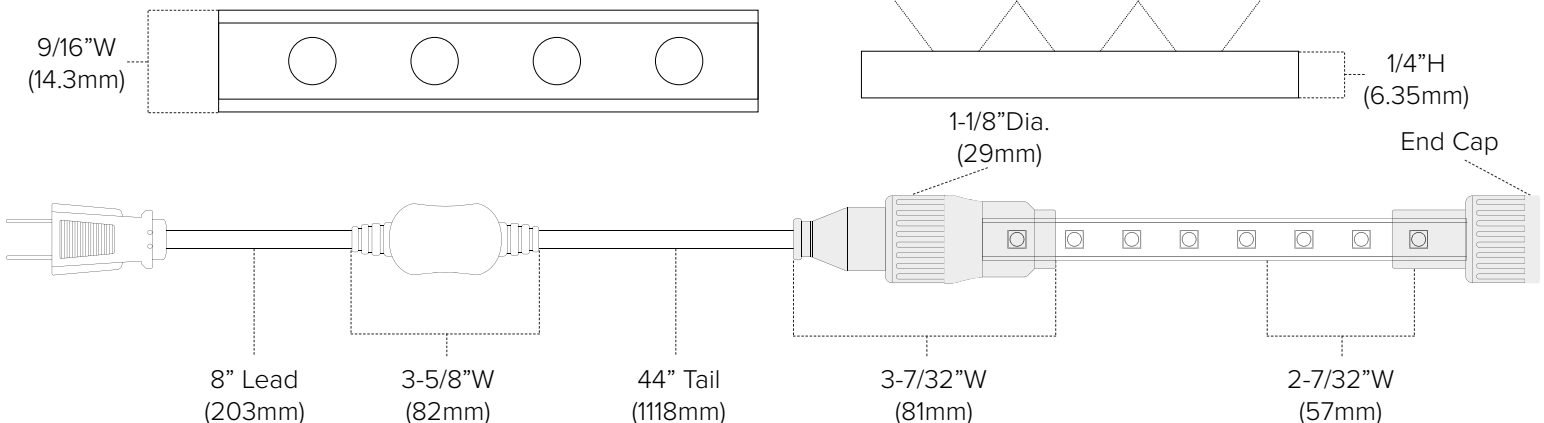

Ordering Information

120V Kits

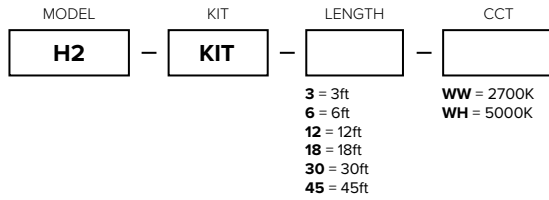





Hybrid 2 120V Kits Include:

- (1) 5ft removable power cord with 8A inverter
- (1) Removable end cap
- Mounting Clips (1 per foot of length)

Example Part # **H2-KIT-3-WW**



Accessories

Image	Part Number	Description
	H2-KIT-JUMP3	3ft jumper/linking cable for Hybrid 2 Kits with twist-and-tighten connectors
	H2-KIT-JUMP10	10ft jumper/linking cable for Hybrid 2 Kits with twist-and-tighten connectors
	H2-KIT-JUMP15	15ft jumper/linking cable for Hybrid 2 Kits with twist-and-tighten connectors
	H2-TRACK-3	3ft clear plastic mounting track (23/32"W x 13/32"H) / Plastic track is recommended for indoor use only
	H2-CHAN-3	3ft aluminum mounting channel (23/32"W x 12/32"H)
	H2-ENDS	Clear plastic end caps for Hybrid 2 (bag of 10)
	H2-CLIPS	Clear plastic mounting clips with mounting screws for Hybrid 2 (bag of 10)

Cut-view when used with
H2-TRACK-3 or H2-CHAN-3
(sold separately)

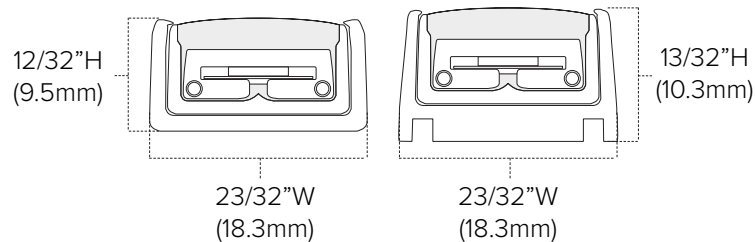

Compatible Dimmers

Brand	Model #	Type	Dimming Range	Notes
Lutron®	DVCL-153P	CFL/LED	10-100%	
Lutron®	DVW-603PH	Magnetic	10-100%	
Lutron®	DNG-600PH	Incandescent	10-100%	
Lutron®	DVELV-300P-LA	ELV	10-100%	
Leviton®	Sureslide 6613	Incandescent	10-100%	

Dimmer performance may vary in field application due to unknown external factors. Dimmers not included on the chart above are not necessarily incompatible; they have yet to be fully evaluated. Please reference dimmer manufacturer's instructions for more detailed information regarding performance and compatibility.

DO NOT TWIST, HANG VERTICALLY, SUSPEND UNSUPPORTED IN THE MIDDLE, OR BEND ALONG SHORT SIDE

